

Wideband RF Impedance Matching Transformers

Designed for use in 50 Ω Impedance RF, and Fast Rise Time, Pulse Applications.

Isolation 500V_{RMS} minimum • Operating Temperature Range: +0 to +70 °C

Electrical Specifications at 25° C

DIP Part No.	Impedance Ratio (±5%)	Schem. Style	Pri. Ind. min. (μH)	Rise Time max. (ns)	L _p max. (μH)	Pri./Sec. C _{w/w} max. (pF)	Pri. DCR max. (Ω)	Sec. DCR max. (Ω)	-3 dB Loss Low MHz	BW High MHz
T-12001	1:1	B	80	2.2	0.15	12	0.20	0.20	0.05	110
T-12002	1CT:1CT	C	80	3.0	0.18	15	0.20	0.20	0.05	90
T-12003	1:1CT	D	80	3.0	0.18	15	0.20	0.20	0.05	90
T-12004	1:1:1	A	40	2.0	0.10	12	0.16	0.16	0.10	150
T-12005	1:4	B	40	3.0	0.14	15	0.20	0.30	0.10	110
T-12006	1:4CT	D	40	3.0	0.14	15	0.20	0.30	0.10	110
T-12007	1:2	B	80	4.0	0.30	18	0.20	0.30	0.05	50
T-12008	1:2CT	D	80	3.0	0.20	18	0.20	0.30	0.05	80
T-12009	1:16	B	20	6.0	0.10	10	0.20	0.60	0.20	60
T-12010	1:16CT	D	20	6.0	0.10	10	0.20	0.60	0.20	60

DIP Part Number	Impedance Ratio	Frequency Range (MHz)			Schematic Style
		Insertion Loss 3 dB	Insertion Loss 2 dB	Insertion Loss 1 dB	
T-12050	1:1	.050-200	.080-150	.20-80	D
T-12051	1:1	.003-300	.010-150	.02-50	D
T-12052	2:1	.070-200	.100-100	.50-50	D
T-12053	2.5:1	.010-100	.020-50	.05-20	D
T-12054	3:1	.050-250	.100-200	.50-70	D
T-12055	4:1	.200-350	.350-300	2-100	D
T-12056	4:1	.020-250	.050-150	.10-100	D
T-12057	5:1	.300-300	.600-200	.50-100	D
T-12058	8:1	.030-140	.100-90	1-60	D
T-12059	13:1	.300-120	.700-80	5-20	D
T-12060	16:1	.030-75	.060-30	10-20	D
T-12061	1:1	.150-400	.350-200	2-50	B
T-12062	1:1	.010-150	.020-100	.005-50	B
T-12063	1.5:1	.100-300	.200-150	.50-80	B
T-12064	1.5:1	.020-100	.050-50	.10-25	B
T-12065	2.5:1	.010-100	.020-50	.05-20	B
T-12066	4:1	.020-200	.050-150	.10-100	B
T-12067	9:1	.150-200	.300-150	2-40	B
T-12068	16:1	.300-120	.700-80	.50-20	B
T-12069	36:1	.030-20	.050-10	.10-5	B
T-12070	1:1	.004-500	.020-200	.10-50	C
T-12071	1.5:1	.075-500	.200-100	.10-50	C
T-12072	2.5:1	.010-50	.025-25	.05-10	C
T-12073	4:1	.050-200	.200-50	1-30	C
T-12074	25:1	.020-30	.050-20	.10-10	C

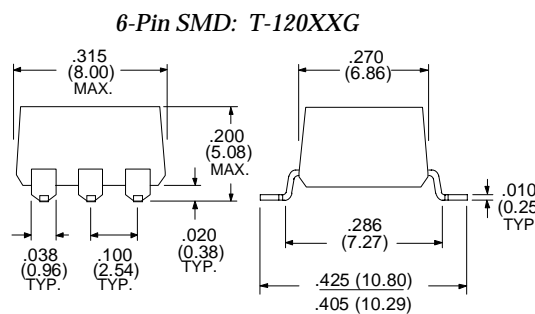
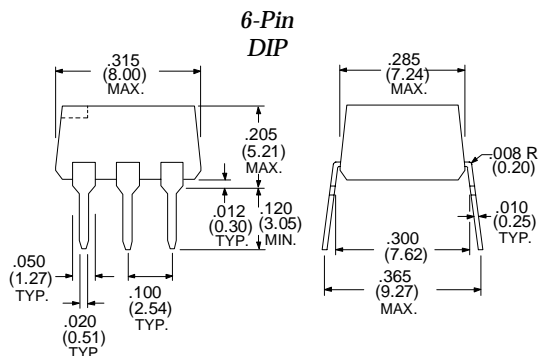
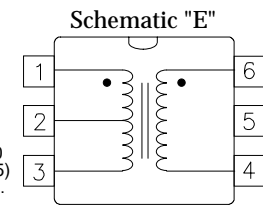
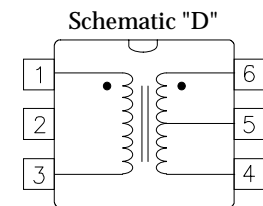
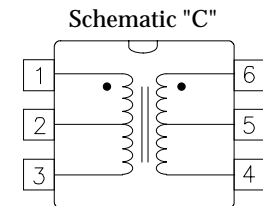
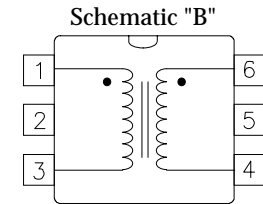
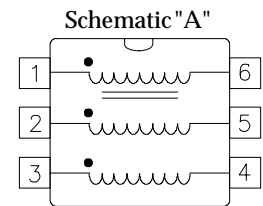

Add "G" to P/N for SMD
Tape & Reel available