

High Isolation Pulse Transformer

Part Number T-925

Turns Ratio	(± 2%)	1:1:1
-------------	----------	-------

Parameter	Min.	Max.	Units
Inductance (Primary)	4.0		mH
Leakage Inductance		11.0	μH
Capacitance (C _{www})		35	pF
Primary DC Resistance		0.90	ohms
Secondary DC Resistance	Sec 1	0.76	ohms
	Sec 2	1.10	ohms
ET Constant	240		V-μS
Isolation	4000		V _{RMS}

Schematic Diagram

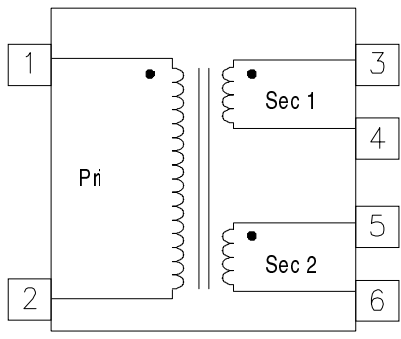

Physical Dimensions in inches (mm)

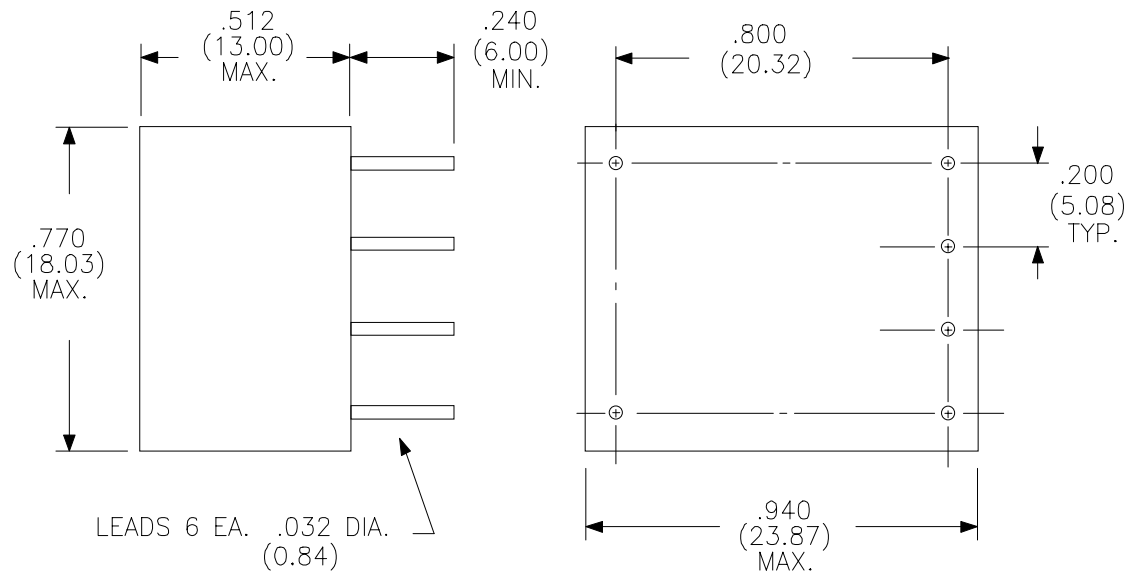

07/11/96