

10 BASE-T QUAD PORT TRANSFORMER

■ Fast Rise Times

■ IEEE 802.3 Compatible

■ Meets ECMA Requirements

■ Operating temperature Range
-45°C to +85°C

Electrical Specifications at 25° C

Part Number	Turns Ratio (+2%)	Sine Wave Inductance (μH MIN) ¹	Interwinding Capacitance (pF MAX) ¹	Leakage Inductance (μH MAX) ¹	Return Loss 5 to 10mHz (dB MIN)		Common Mode Rejection TX (dB MIN)					Hipot (VRMS MIN)
					100 Ω	98±13Ω	5 mHz	10 mHz	50 mHz	100 mHz	200 mHz	
T-17400	1CT : 1CT	150	10	0.30	-20	-15	-60	-50	-35	-25	-20	1500

1. Measured at 20 mVrms, 100 kHz.

Insertion Loss : Typically -0.5 dB maximum from 1 to 10 mHz.

Crosstalk : From 1 to 10 mHz is -35 dB minimum.

Schematic Diagram

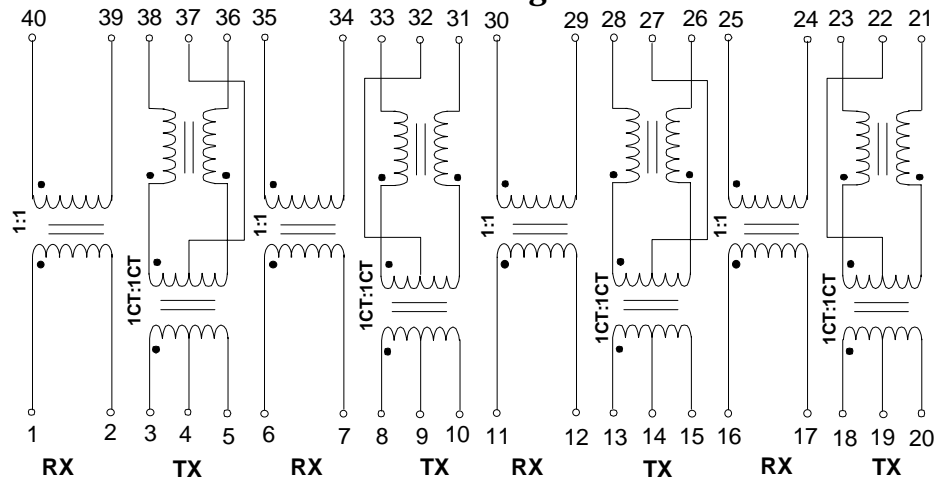

Dimensions in inches (mm)

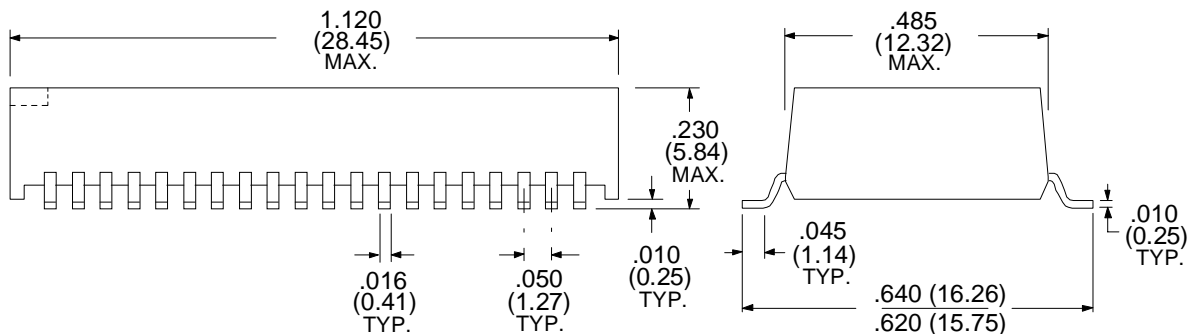

RHOMBUS P/N: **T-17400**

CUST P/N:

NAME:

DATE: **02/16/00**

SHEET: 1 OF 1