

ISDN TRANSFORMERS "U" INTERFACE

P/N T-1054

Parameter	Min.	Typ.	Max.	Units
Inductance (1-4), Shorted pins 2,3 ⁽¹⁾	13.0	14.5	15.95	mH
Inductance (1-4), Shorted pins 2,3 ⁽²⁾	12.4			mH
Leakage Inductance ⁽³⁾		44		μ H
Interwinding Capacitance ⁽³⁾		50		pF
DC Resistance (1-4) With pins 2-3, Shorted			12.5	Ω
DC Resistance (5-6)			8.9	Ω
Hi-Pot Pins (1-10) to	2500			V _{RM}
Primary Impedance, Z _p	128	135	141	Ω
Secondary Impedance, Z _s		78		Ω

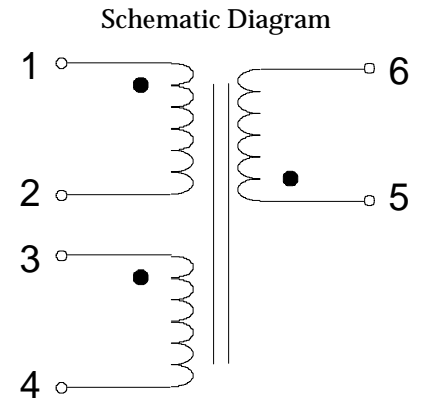

1. Measured at 40 kHz, 1.0 Vrms, 0 mAdc.
2. Measured at 40 kHz, 1.0 Vrms, 40 mAdc.
3. Measured at 100 kHz.

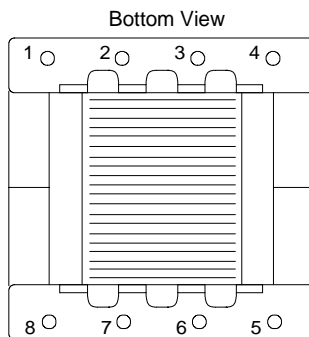
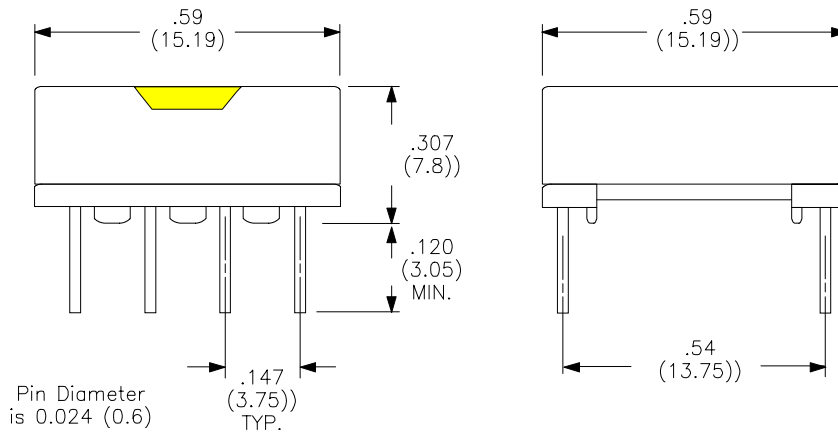

Physical
Dimensions
inches (mm)

4/3/98