

# SMPS Inductor

Iron Powder Material (Hydrogen Reduced)

Well Suited for Switch Mode Power Supplies and Regulator Applications.

Toroid Mount Available

Wire UL rated Class B (130°C) or better

Schematic Diagram

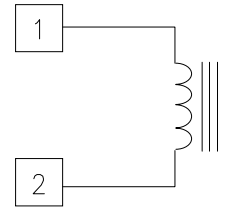

Electrical Specifications at 25°C

Part Number	L <sup>(1)</sup> ( $\mu$ H) Typ.	ET <sub>OP</sub> <sup>(2)</sup> (V $\mu$ S) Max.	I <sup>(3)</sup> max. Amps	Energy min. <sup>(4)</sup> ( $\mu$ J)	DCR Max. (m $\Omega$ )	Lead Size AWG
L-20421	100	90	2.6	338	100	24

1) Typical Inductance in circuit.

Inductance (No DC) 92 $\mu$ H  $\pm$ 20% Tested @ 20 KHz & 90mV

2) Operational ET

3) Maximum DC current. This value is for a 15°C temperature rise due to core loss.

4) Energy storage capability of component in micro Joules.

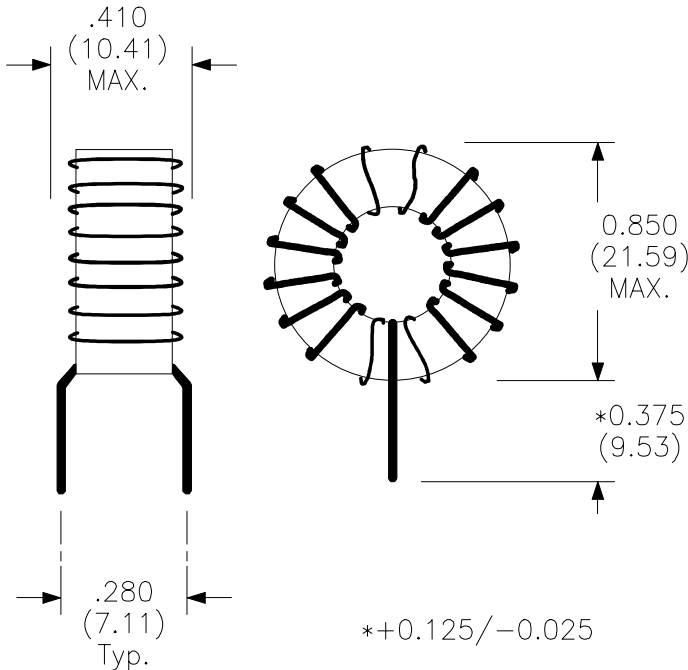

Physical Dimensions  
inches (mm)

RHOMBUS P/N: L-20421

CUST P/N:

NAME:

DATE: 2/14/97

SHEET: 1 OF 1