

Surface Mount Self-Leaded Inductor 150 kHz

Electrical Specifications at 25°C. Operating Temp. Range: -30°C to +130°C

Part Number	L ⁽¹⁾ with DC (μ H)	I _{DC} ⁽¹⁾ (Amps)	E-T ⁽¹⁾ Product (V- μ s)	DCR max. (Ω)
L-15356	54	1.0	16.2	0.2

1) Typical values for a 55°C Temperature rise at 150 kHz and E-T value above, the core loss is 10 % of copper loss.

Schematic Diagram

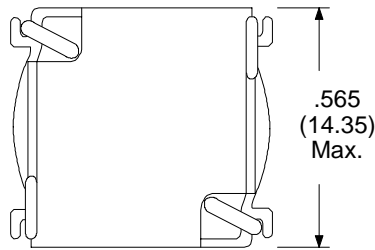

Physical Dimensions
inches (mm)

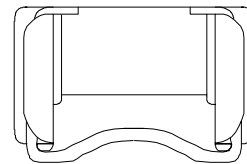
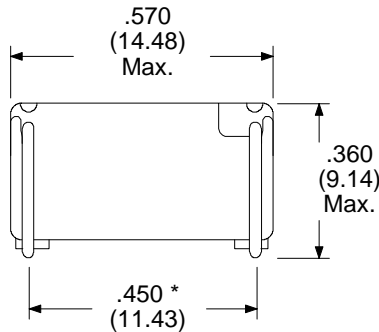

* Tolerance \pm .015 (0.38)

** Tolerance \pm .005 (0.15)

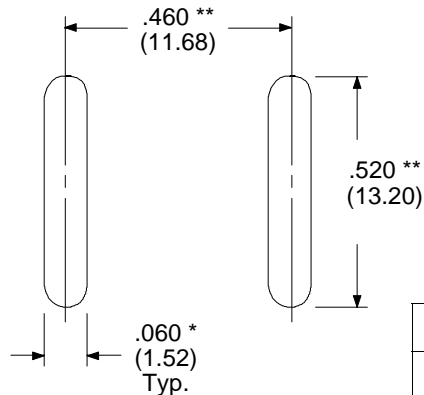

Suggested PCB Layout

RHOMBUS P/N: L-15356

CUST P/N:

NAME:

DATE: 7/30/96

SHEET: 1 OF 1