

# Surface Mount Self-Leaded Inductor 150 kHz

Electrical Specifications at 25°C. Operating Temp. Range: -30°C to +130°C

Part Number	L <sup>(1)</sup> with DC ( $\mu$ H)	I <sub>DC</sub> <sup>(1)</sup> (Amps)	E-T <sup>(1)</sup> Product (V- $\mu$ s)	DCR max. ( $\Omega$ )
L-15344	176	0.3	26.4	1.4

Schematic Diagram

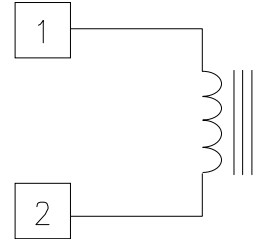

1) Typical values for a 55°C Temperature rise at 150 kHz and E-T value above, the core loss is 10 % of copper loss.

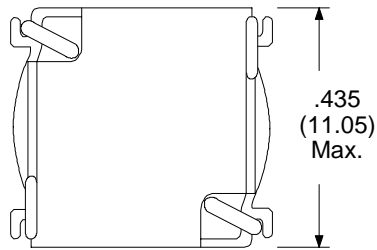

Physical Dimensions  
inches (mm)

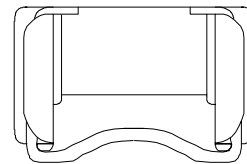
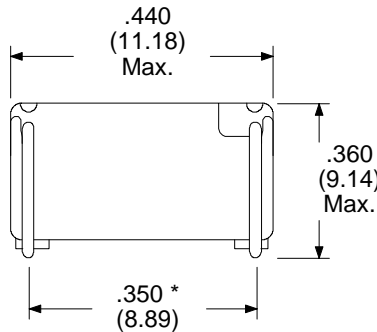

\* Tolerance  $\pm$  .015 (0.38)

\*\* Tolerance  $\pm$  .005 (0.15)

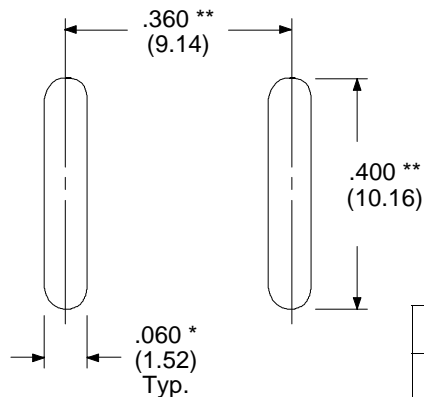

Suggested PCB Layout

RHOMBUS P/N: L-15344	
CUST P/N:	NAME:
DATE: 7/30/96	SHEET: 1 OF 1