

Surface Mount Common Mode Choke

Schematic
Diagram

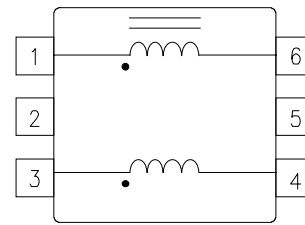

Electrical Specifications at 25° C

Part Number	Pri. Ind. OCL, Min. (μH)	DCR Max. (Ω)	Hi-Pot Min. V _{RMS}	Common Mode Attenuation (dB)							
				100k	1M	10M	30M	50M	100M	300M	500M
F-1900	47	0.3	500	3	20	33	37	35	27	9	4

Operating Temperature Range: 0 °C to +70 °C

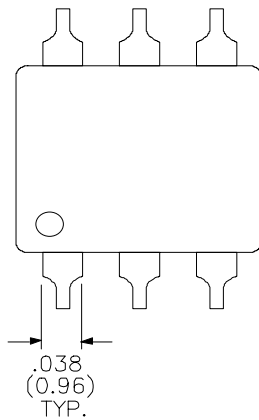

Physical
Dimensions

inches (mm)

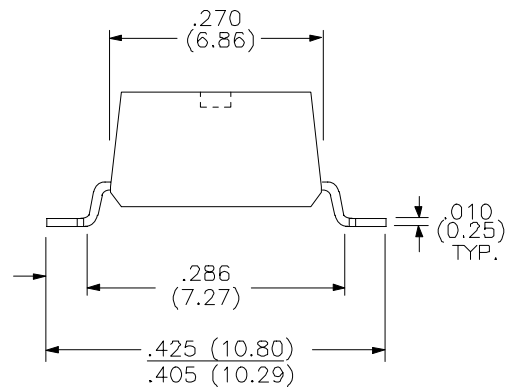
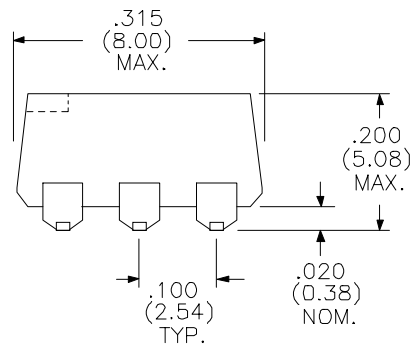

RHOMBUS P/N: F-1900	
CUST P/N:	NAME:
DATE: 1/13/99	SHEET: 1 OF 1